

User Guide

Storage Tower IX (ST95HPMXA)

www.addonics.com

v5.1.11

Technical Support

If you need any assistance to get your unit functioning properly, please have your product information ready and contact Addonics Technical Support at:

Hours: 8:30 am - 6:00 pm PST

Phone: 408-453-6212

Email: <http://www.addonics.com/support/query/>

Removing Cover of Storage Tower IX

Loosen the 5 screws at the back of the tower using a Philips screwdriver by turning counter-clockwise. Separate the metal casing of the tower from the housing by lifting up the casing.

Installing drives into the Storage Tower

Step 1

Screw the hard drives into the optional mounting brackets or slide in 5.25" devices into the tower. Other types of enclosures like the 5SA disk array can also be mounted. Mounting three 5SA disk array allows you to mount a maximum of 15 SATA drives.

Step 2

Using 3.5" SATA Hard Disk Drives
Connect the internal SATA data cable to the data port of the hard drive then connect the 15-pin SATA power connector to the power port on the hard drive.

Step 3

Secure the hard disk by using screws provided. Repeat the above procedure for additional hard drives.

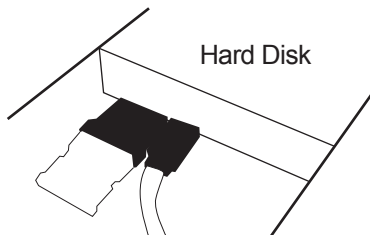
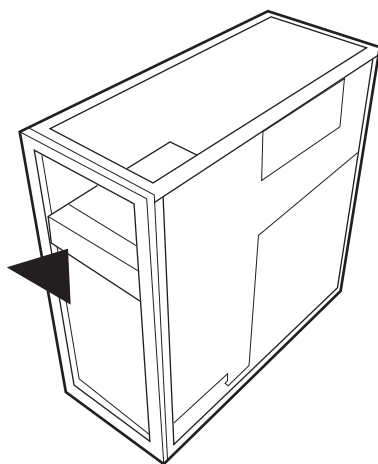
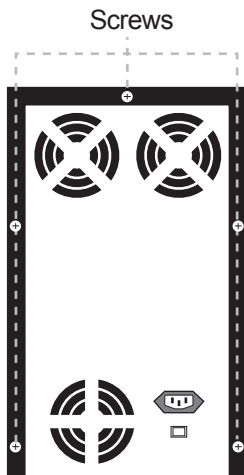

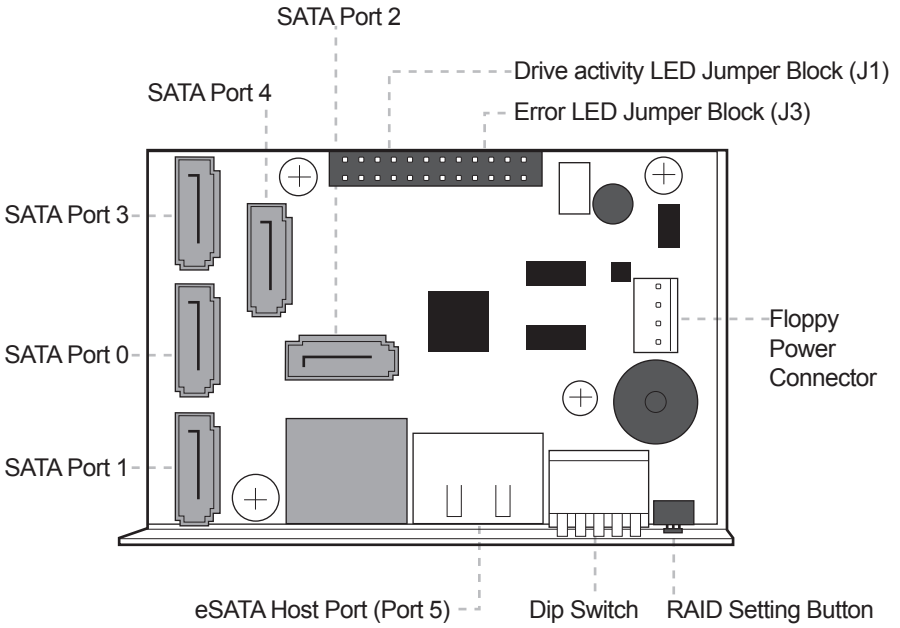

	Dip Switch Settings				
Raid Mode	1	2	3	4	5
Individual Drive (Factory Default)	OFF	OFF	OFF	OFF	OFF
0	OFF	OFF	ON	ON	ON
1 and 10	OFF	OFF	ON	ON	OFF
3	OFF	OFF	ON	OFF	OFF
5	OFF	OFF	OFF	ON	OFF
Clone	OFF	OFF	OFF	ON	ON
Large	OFF	OFF	ON	OFF	ON
	Enable ERR Buzzer Function	Auto- Rebuilding to Spare Drive	Port Multiplier Mode		

Default factory DIP Switch setting:

SW1 – RAID Setting DIP Switch

BZS – Error buzzer function

EZ – Automatic rebuilding to spare drive (one of the drives on the raid is set as a spare). If EZ is ENABLED and a drive failure occurs, the spare will automatically act as a drive replacement and rebuilding will automatically start.

M2 – RAID mode 2

M1 – RAID mode 1

M0 – RAID mode 0

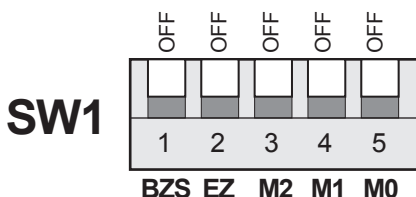

1. Error buzzer function is ENABLED (BZS) when dip switch is in OFF position
2. Auto-rebuilding to spare drive is DISABLED (EZ)
3. Individual drive mode is ENABLED (M0~M2)

Note: When the default factory RAID setting is used, independent drive configuration and optical drive are supported only when connecting to controllers with Silicon Image Sil3124, Sil3132 chip set or controllers that are Port Multiplier (PM) compatible. Simultaneous DVD writing was tested using the Nero Burning Rom.

LED Pin Header

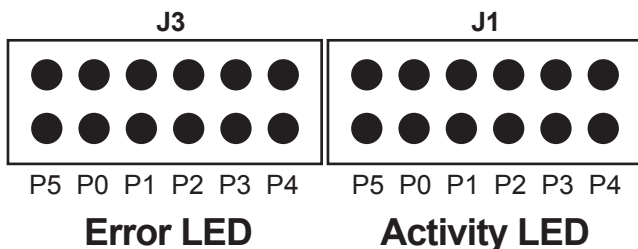

J1 – Drive Activity LED

P5 – Activity LED for eSATA host port lights up when it is connected to a SATA controller card.

P0, P1, P2, P3 & P4 - Activity LEDs for port 0, 1, 2, 3, 4 & 5 light up when a drive is connected and blinks when there's drive activity.

J3 – Error LED

P5 – error LED for eSATA host port

P0, P1, P2, P3 & P4 - error LED for port 0, 1, 2, 3, 4 & 5

Setting or Modifying the RAID Mode Using the JMicron HW RAID Manager Utility Program:

1. For Windows users, install the JMicron HW RAID Manager located on the SATA Controller CD. In the CD, go to Configuration Utilities > JMB393. This manager can be used to create and monitor the status of the RAID volume.

It is recommended to use the default factory RAID DIP switch setting when using the JMicron HW RAID Manager.

2. Modify the RAID mode on the 5-port HPM-XA using DIP switch

Recommended to be used on operating system without JMicron HW RAID Manager support like Linux, Mac & Solaris. Windows users can also use the procedure below.

Note: Steps A to D need to be performed each time the raid mode is modified.

- a. Set the DIP switch as shown below.

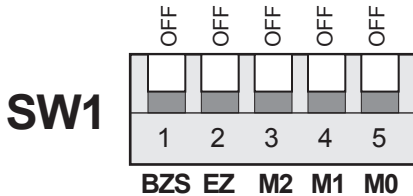

- b. Press the RAID setting button with a ball point pen.
- c. While pressing the RAID setting button turn on the system power where the HPM is connected. The buzzer will sound while holding the RAID setting button. Release it after at least 5 seconds for hardware initialization. A single beep will be heard to indicate initialization is completed. The above steps act as a reset.
- d. Power off the system power.

- e. On the DIP switch, change (M0 to M2) setting to the desired RAID mode using the diagram below.

All settings on the diagram shows

- Error buzzer function is ENABLED
- EZ function is DISABLED.

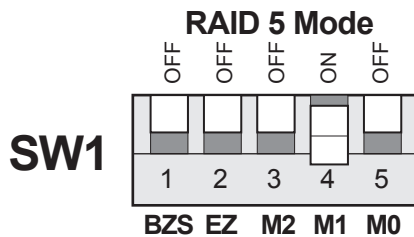
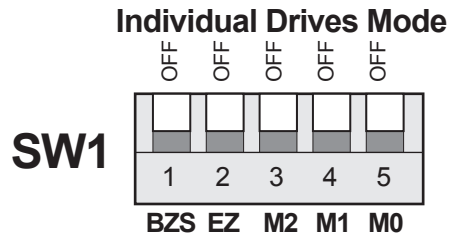
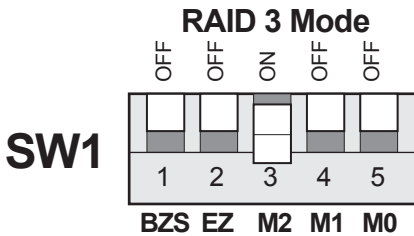
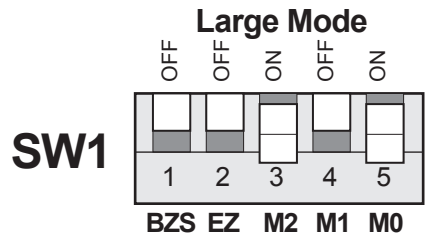
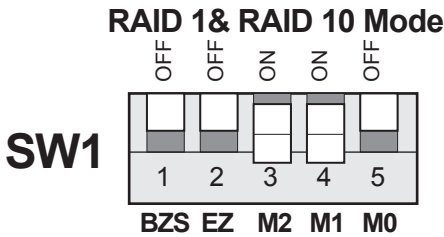
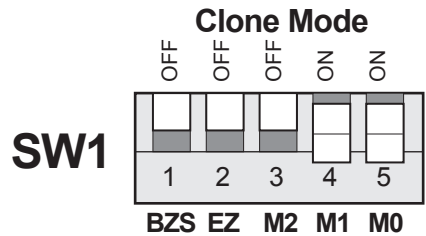
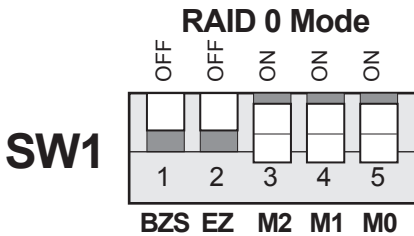

RAID Setting Notes:

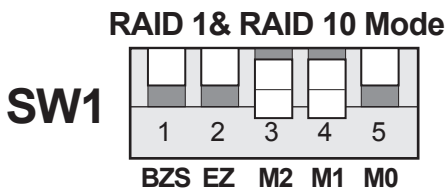

When 2 drives are connected to the HPM-XA, and DIP switch is set to this setting, the 2 drives will be configured as a 2-drive RAID1 array.

When 4 drives are connected to the HPM-XA, the 4 drives will be configured as a 4-drive RAID10 array.

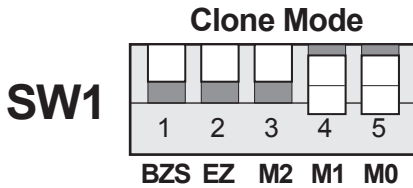

Clone's action is similar to RAID1. However, all of the hard drives will be mirrored. Clone mode is useful especially when users like to copy data from a source hard drive to the drives connected to the HPM-XA.

- f. Press the RAID setting button with a ball point pen.
- g. While pressing the RAID setting button turn on the system power where the HPM is connected. The buzzer will sound while holding the RAID setting button. Release it after at least 5 seconds for hardware initialization. A single beep will be heard to indicate initialization is completed.
- h. Verify if the RAID array is detected by the system.
- i. If the 5-port HPM-XA is connected to the motherboard onboard SATA, on the CMOS setup utility, the raid array will display as "Addonics H/W RAID5" if setup as a RAID5 array.
- j. If the 5-port HPM-XA is connected to an eSATA host controller card, on the RAID BIOS, the raid array will display as "Addonics H/W RAID0" if setup as a RAID0 array.
- k. If booted into Windows, in Disk Drives under Device Manager, the raid array will display as "Addonics H/W LARGE" if setup as a LARGE array.
- l. Once raid array is verified, you can set the buzzer either ON or OFF.

Notes on Spare Drives using the Easy RAID Setting (EZ)

When EZ function is ENABLED, the auto-rebuilding to spare drive is automatic. The degraded RAID group will start rebuilding automatically by using the existing spare drive.

* Spare drive can be either plugged before RAID building or a new drive can be plug as the spare drive when RAID rebuild is required.

A. Which port acts as a spare drive?

The last drive will automatically become the spare drive.

For a 3-drive RAID5 with spare:

Drives connected to SATA ports 1~3 belong to the active RAID5 array and drive connected to port 4 is the spare.

For a 4-drive RAID10 with spare:

Drives connected to SATA ports 1~4 belong to the active RAID10 array and drive connected to port 5 is the spare.

For a 2-drive RAID1 with spare:

Drives connected to SATA ports 1& 4 belong to the active RAID1 array and drive connected to port 5 is the spare.

B. When will rebuild action start?

- When the raid fails and EZ is enabled, the HPM-XA will automatically rebuild the RAID group using the spare.
- When the raid fails and EZ is disabled, the HPM-XA will NOT rebuild the raid group unless you install a good drive to replace the failed drive.

Connecting the Power Cable and Storage Tower to the Computer

- Connect the power cord provided from the wall outlet to the back of the tower.
- Make sure the power is off (power LED light should be off).
- Connect the eSATA cable from the back of the tower to the eSATA port on the computer.

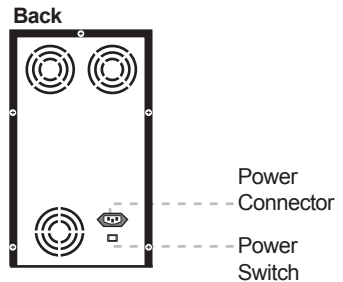

Power on/off control

- A main power switch is located at the back of the tower. Turn the switch on. Another auxiliary switch is located on the front of the tower.
- Make sure the power is off on the auxiliary switch (power LED light should be off).
- Power on the tower.

