

High-Speed Duplicator Controller user manual

I. INTRODUCTION	3
1. Features.....	3
2. Control Panel Overview	4
3. Specifications	5
II. WARNING	5
III. OPERATION OVERVIEW	6
1. Copy.....	7
2. Compare.....	7
3. Copy + Compare	7
4. Capacity Check	8
5. Utility.....	8
5.1. Format FAT32.....	8
5.2. Format exFAT	8
5.3. Measure Speed	9
5.4. Quick Erase.....	9
5.5. Full Erase.....	9
5.6. DoD Erase	9
5.7. Change Disk Signatures.....	10
5.8. Media Information.....	10
5.9. Device Model	10
5.10. System Information	11
5.11. System Update	11
6. Setup.....	11
6.1. Copy Area	11
6.2. Smaller Target	12
6.3. Unknown Format	12
6.4. Check Before Copy	12
6.5. Display Mode	13
6.6. Start-up Menu	13
6.7. Button Beep	14
6.8. Show Result Time.....	14
6.9. Boot Password.....	14
6.10. Setup Password.....	14

High-Speed Duplicator Controller user manual

6.11.	Language	15
6.12.	Clear Setup	15
6.13.	Performance	15

I. Introduction

The Addonics High-Speed duplicator controller is designed to not sacrifice speed for the increasing number of targets loaded - always remain the same and fast copy speed. The duplicator supports fast copy with multiple file formats created by three major operating systems (Windows/Linux/macOS), and makes mirror copies of data efficiently. GPT and MBR partition formats, and 4K advanced format hard disk drive (HDD) are all supported. Furthermore, this duplicator has been fully tested with quality assurance before leaving our manufacturing facility.

1. Features

- a. Each processing channel has its own control unit and operates independently with dedicated bandwidth of up to 150MB per second.
- b. Standalone operation. No PC or software is required, minimizing possible computer virus infection.
- c. Instant power on and off, no warm-up or cool-down required.
- d. Easy-to-use One-Touch copy operation.
- e. Compare function available for verification of copy accuracy.
- f. Menu options are user-friendly and easily accessed through the 4-button control panel. Use ▲ or ▼ button to scroll through the options and view the operation status of each channel on the 2-line backlit LCD display.
- g. Powerful 32-bit CRC checksum to assure data integrity.
- h. Heavy-duty hardware construction for commercial production or personal use..
- i. Designed to save users time and effort in creating multiple copies quickly and reliably.
- j. Unique source data analysis to copy data area only to achieve highest efficiency.
- k. Supports multiple file systems: Windows: FAT16/32, exFAT, NTFS, Linux: ext2/3/4, macOS: HFS, HFS+, HFSX.

2. Control Panel Overview

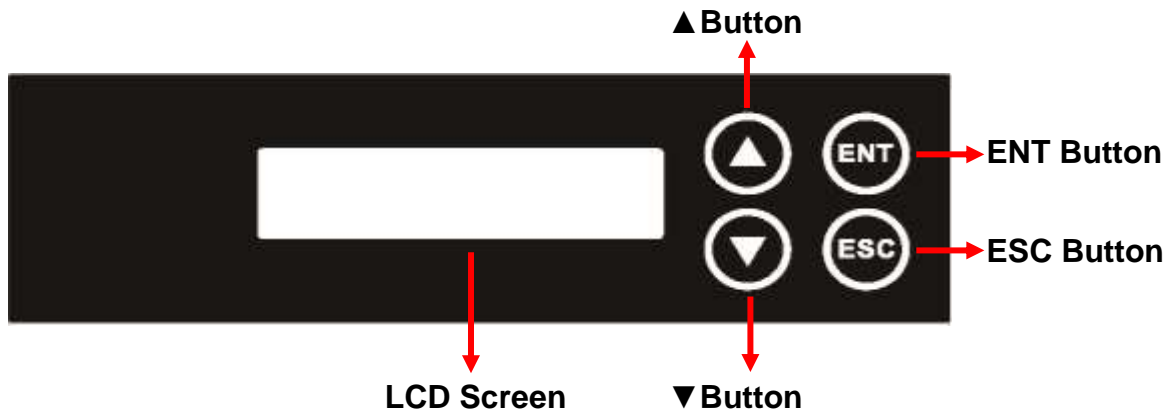

▲ Button: Up, Backward: To navigate backward in the menu.

▼ Button: Down, Forward: To navigate forward in the menu.

ENT Button: Enter, OK: Execute the function.

ESC Button: Escape, Cancel: Go back to the previous level in the menu.

High-Speed Duplicator Controller user manual

3. Specifications

Operation	Standalone (No PC or Software is required)
Writing Mode	Sector by Sector
SATA Port No.	5
Transfer Rate	150 MB/s (Actual transfer rate depends on the speed of drive)
Copy Area	Whole Media, System and Files(Intelligent Copy)
Supported Media	SATA 1/2/3 HDD/SSD
Supported File Systems (for Intelligent Copy)	Windows : FAT16/32, exFAT, NTFS Linux : ext2/3/4 macOS : HFS, HFS+, HFSX
Display	2-line Backlit Monochrome LCD
Control Button	4 push-button control panel (ENT, ESC, UP, DOWN)
Data Buffer	DDR3 128MB
Operating Environment	5°C ~ 45°C, 20%~80% RH
Storage Environment	-20°C ~ 85°C, 5~95% RH

II. Warning

1. The duplicator tasks mentioned in this user's manual are as following: Copy, Compare, Copy + Compare, Capacity Check, and the functions under Utility sub menu, such as Format FAT32, Format exFAT, Quick Erase, Full Erase, DoD Erase and Secure Erase.
2. The Green LED flashes during the execution process of a task. After the task is done, the Green LED will stay solid if the process is successful, otherwise the Red LED will be on if the process is failed.
3. Press and hold **ESC** button during the execution process of a task will stop and exit the execution of the task.
4. DO NOT unplug HDD from the duplicator during the execution process of a task. It may cause damage to the duplicator system and media.

High-Speed Duplicator Controller user manual

5. It is strongly recommended that the capacities of the source and target media are equal or similar.

III. Operation Overview

The duplicator will start to execute a task after the source and target devices have been inserted and the ENT button is pressed. The task will begin and end at the same time for all target devices. Any other target device plugged in during the process of a task will not be executed with the task.

- a. Insert source media into the source channel and blank media into the target channels properly. The LCD display will show no source disk when source media is not plugged in yet, and show the number of target media inserted when source media plugged in.
- b. The green LED will be on if the target device is plugged in properly.
- c. Select the task from menu, and press **ENT** button to execute it.
- d. During the execution process, the status of each target device can be checked by using the ▲ and ▼ buttons.
- e. After the task is done, LCD display will show the number of successful and failed target(s), and execution time. Go to section **6.9 Show Result Time** to set up the display of time.
- f. If any target failed, LCD display will show the following information.
(The LCD will only show error message when all targets failed).

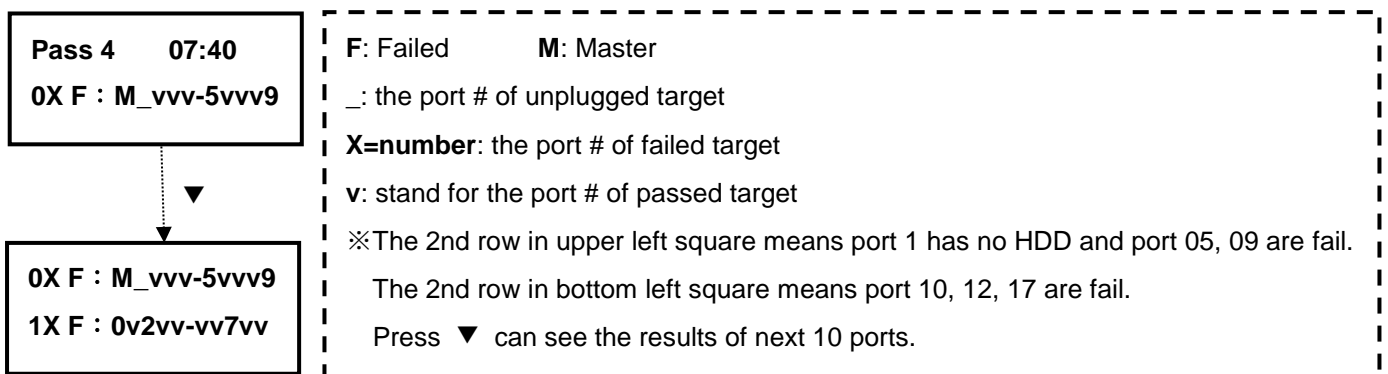

Menu Overview

1. Copy

To copy from source device to target device(s), please go to **6.1 Copy Area** to select the setting first before this step.

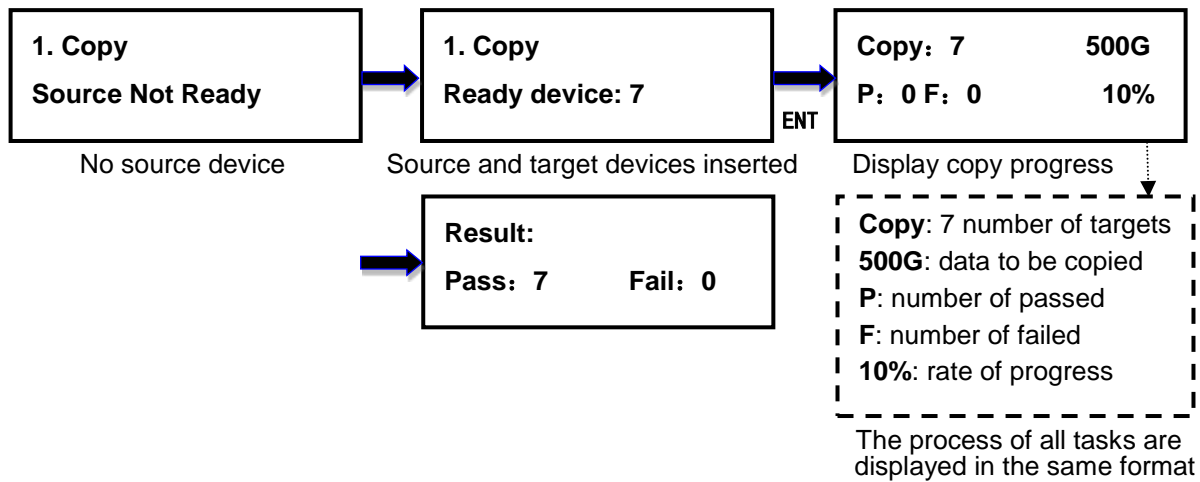

2. Compare

This command allows to compare the copied target devices against the source for accuracy.

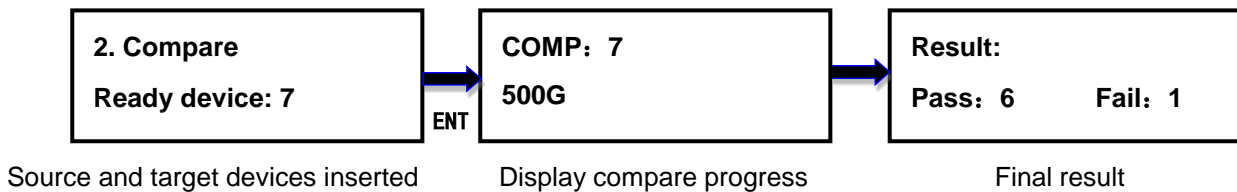

3. Copy + Compare

This command allows duplicator to start Copy process first, then follow with Compare process immediately.

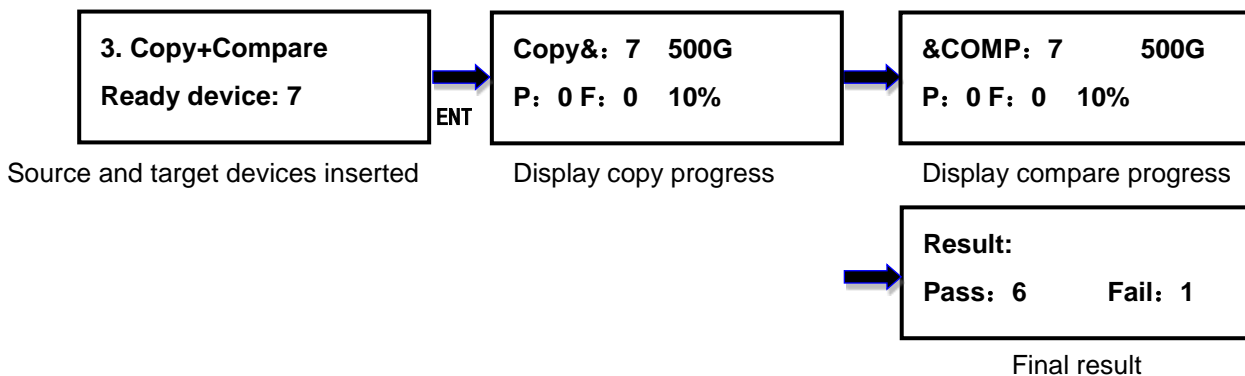

High-Speed Duplicator Controller user manual

4. Capacity Check

This command allows to verify the device capacity. It can detect the actual capacity of devices within 3 seconds.

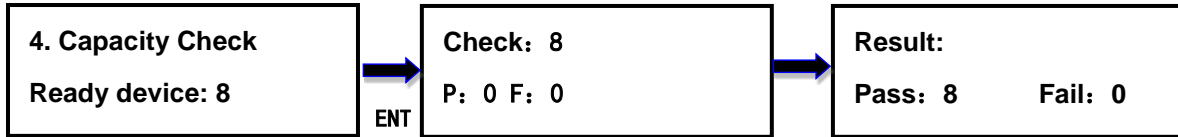

Source and target devices inserted

Display progress status

Final result

5. Utility

5.1. Format FAT32

This option allows to format the target device to FAT32 file system. It will not format the source device, avoiding accidentally erasing the original data content. User will be asked if it is sure to format the target devices before the Format process starts.

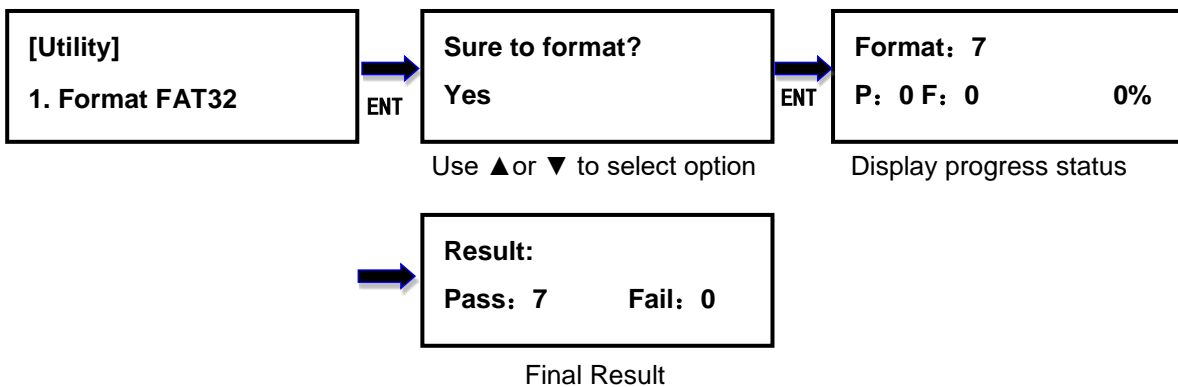

Use ▲ or ▼ to select option

Display progress status

Final Result

5.2. Format exFAT

This option allows to format the target device to exFAT file system. It will not format the source device, avoiding accidentally erasing the original data content. User will be asked if it is sure to format the target devices before the Format process starts.

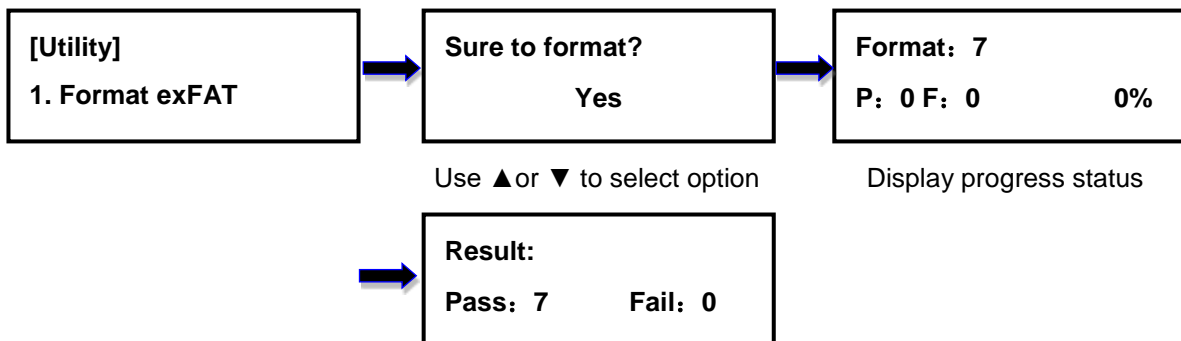

Use ▲ or ▼ to select option

Display progress status

Final result

High-Speed Duplicator Controller user manual

5.3. Measure Speed

This option allows to measure the actual Read and Write speed of the target device. This option will NOT alter or erase existing data on the target device.

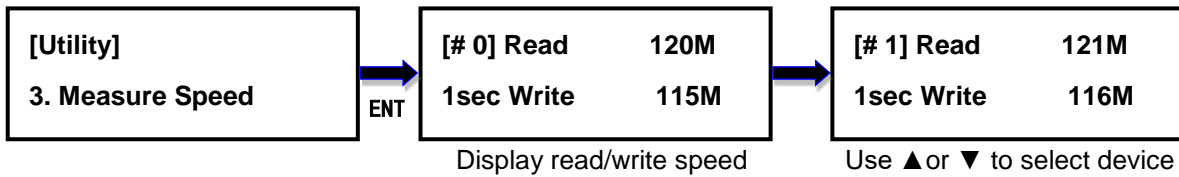

5.4. Quick Erase

This option erases the table of content of file system of the target device, so it is fast to do Quick Erase. There is chance that some files can be retrieved by software.

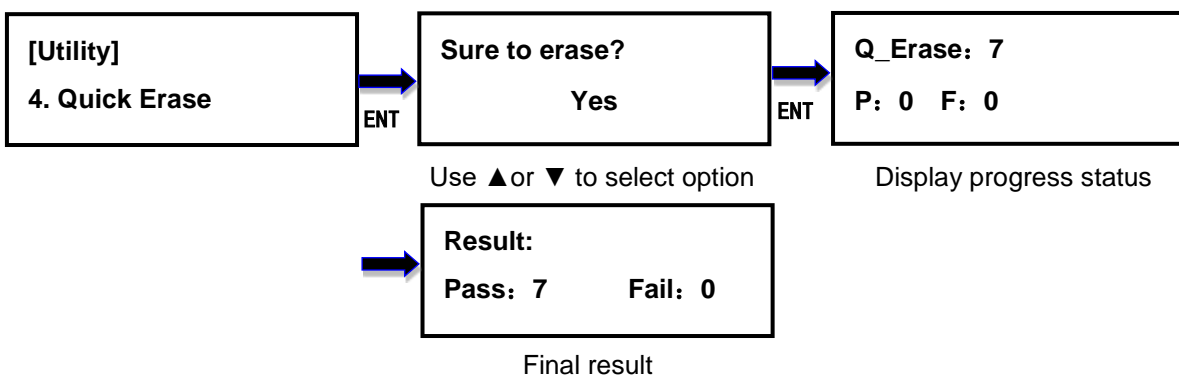

5.5. Full Erase

This option completely erases the content of target device. It takes longer time to erase and the content will not be retrieved by software.

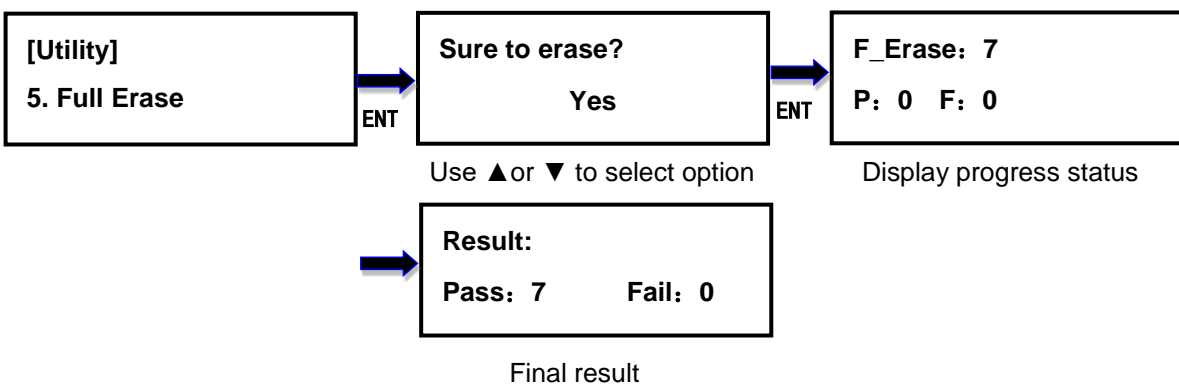

5.6. DoD Erase

This is to comply with the U.S.A. Department of Defense (DoD 5220) standard to fully erase the media by rewriting sector by sector 3 times to guarantee the data to be permanently deleted. It takes the longest time to erase, and the content will not be retrieved by software.

High-Speed Duplicator Controller user manual

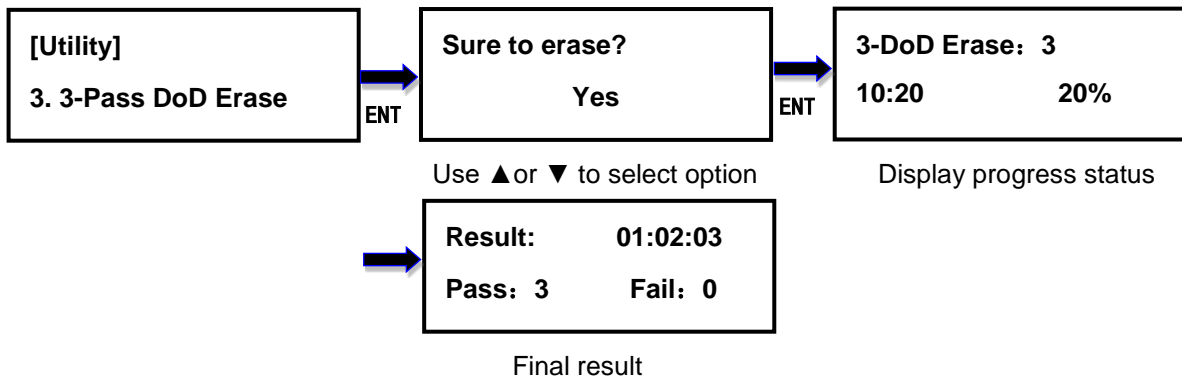

5.7. Change Disk Signatures

Duplicator generates the same disk signatures after copy which may cause computer unable to read the disk correctly when two disks with identical disk signatures are presented, or shut down the computer. This function allows to change disk signature.

Attention: it will cause error (data mismatch) if compare the disks after execution of this function.

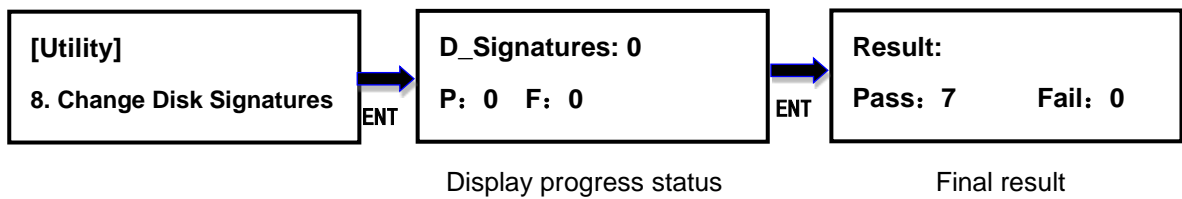

5.8. Media Information

This option displays the information of selected device media, such as total capacity, file system and the size of data content.

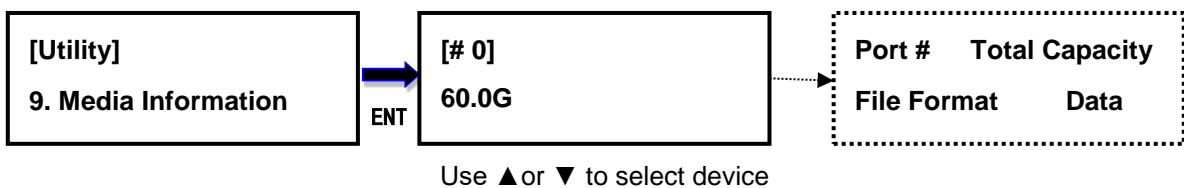

5.9. Device Model

This option displays the model information of selected device, such as device model, serial information and firmware version.

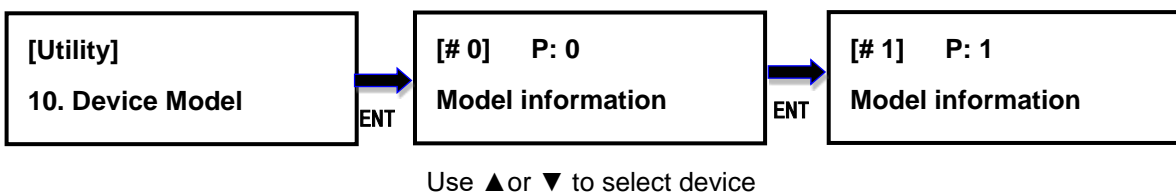

High-Speed Duplicator Controller user manual

5.10. System Information

This option displays general information of the duplicator, including controller model, system memory size, firmware version and number of targets.

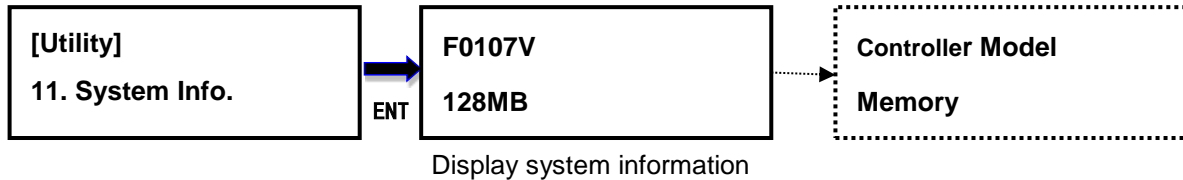

5.11. System Update

This option allows user to update the firmware of duplicator when necessary. Please obtain the proper firmware file from manufacturer, and save the unzipped file under home folder on the hard disk drive **(DO NOT save the file under sub folder)**. Insert the hard disk drive containing the firmware into the source port of duplicator and press ENT. It will update the system, reboot the duplicator after update, active and operate under the new firmware.

Only support FAT32 file system.

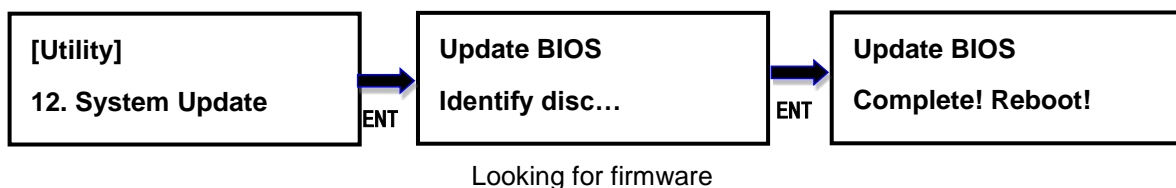

6. Setup

6.1. Copy Area

This option allows to select the area on the source device to copy onto the target devices. You may select either “System and Files” to skip all the unoccupied area on the source device or “Whole Media”. By default, the copy area is set up as [System and Files](#).

System and Files

The duplicator first analyzes the file system of source device. You may copy only the system and files area to save overall copy time if the file system is FAT16/32, exFAT, NTFS (Windows), ext2/3/4 (Linux), and HFS, HFS+, HFSX (macOS). Otherwise, the duplicator will copy the entire source device content to the target devices including unoccupied space. For instance, the source device has 1TB capacity but with only 20GB of data in FAT32 file system. The duplicator will copy only the 20GB of data area to the target device, hence shortening overall copy time.

High-Speed Duplicator Controller user manual

Whole Media

When selected, the duplicator copies the entire content on the source device, including both the data and empty spaces. This option is used when you have a source device with unknown file system. For instance a source device has 1TB capacity and 20GB of data with unknown file system, the duplicator will copy the whole 1TB of content to target device.

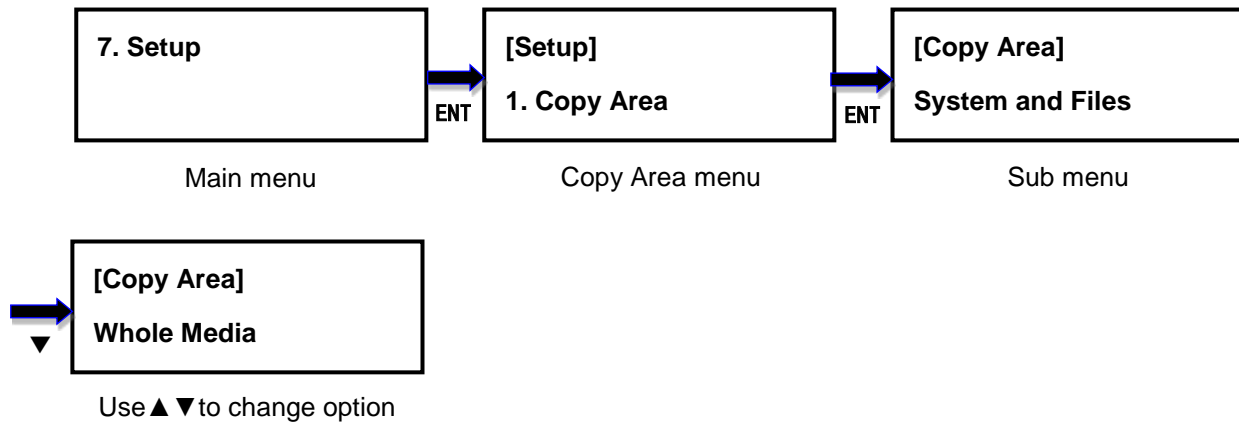

6.2. Smaller Target

If the capacity of the target device is smaller than the source device, the duplicator will partly copy or cannot copy. **Cannot Copy** is the default setting.

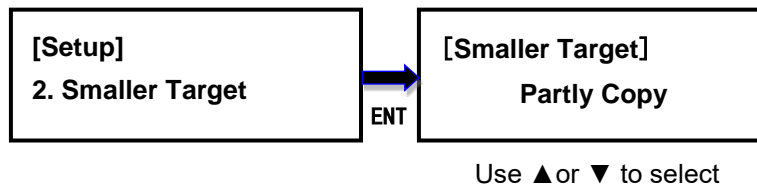

6.3. Unknown Format

This option allows you to Copy or Skip unknown format. If option Skip is selected here, the unknown format from source will not be copied during copy process. **Copy** unknown format is the default setting.

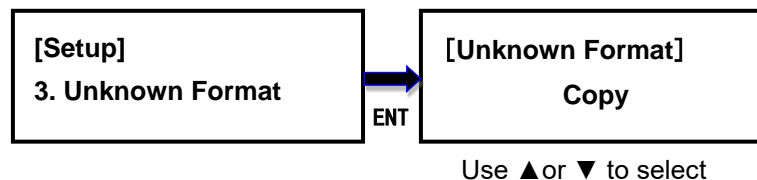

6.4. Check Before Copy

This option allows to check device real capacity before copying. Default setting is **disabled**.

High-Speed Duplicator Controller user manual

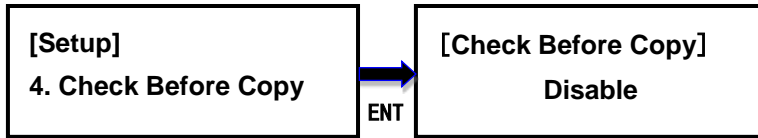

Use ▲ or ▼ to select

6.5. Display Mode

There are three display modes: Basic, Show Timer, and Expert. Basic Mode shows the copy progress in general; Show Timer Mode displays the time used for the task; Expert Mode shows the devices with highest copy speed and lowest copy speed and their copy progress respectively. By default it is [Basic Mode](#).

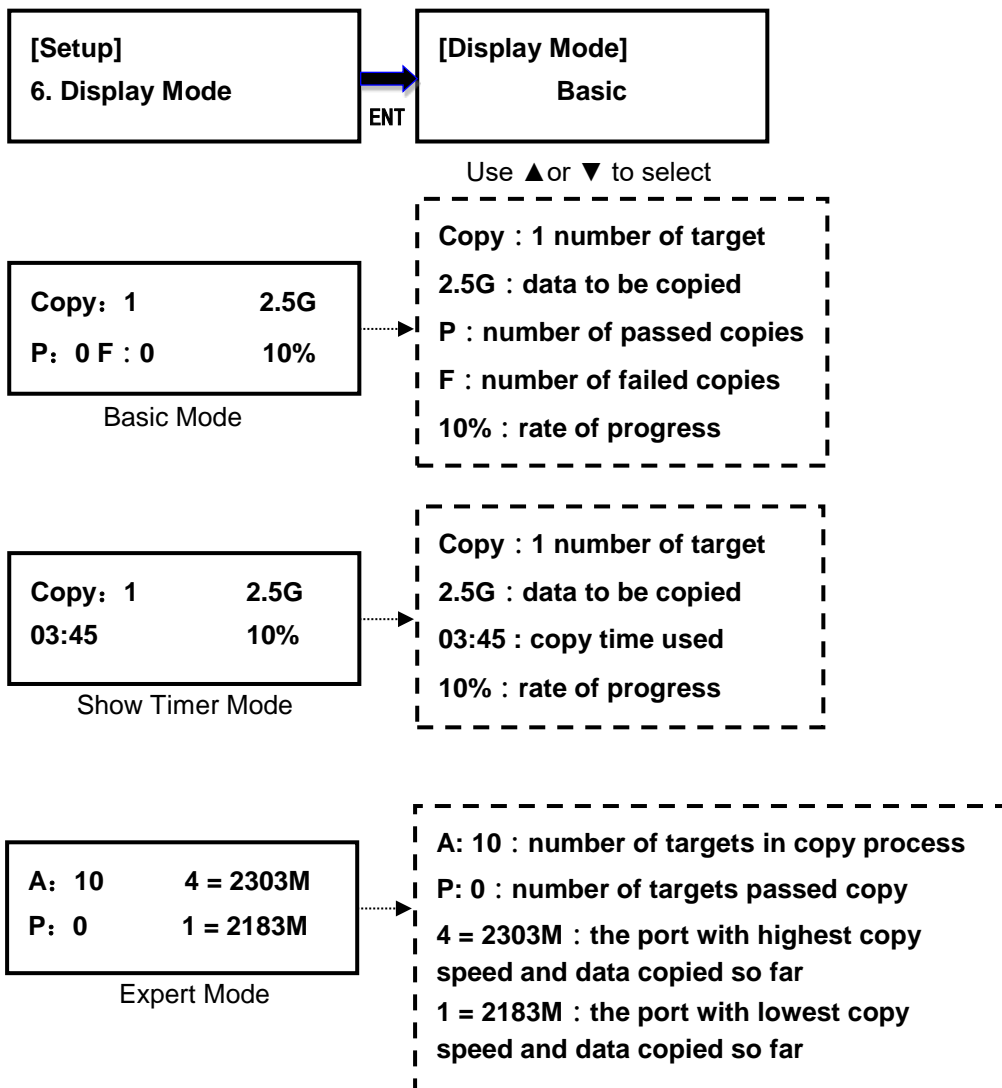

6.6. Start-up Menu

Choose one of the following as the default start-up function: Copy, Compare,

High-Speed Duplicator Controller user manual

Copy+Compare, Capacity Check, Utility and Setup. The default start-up function is [Copy](#).

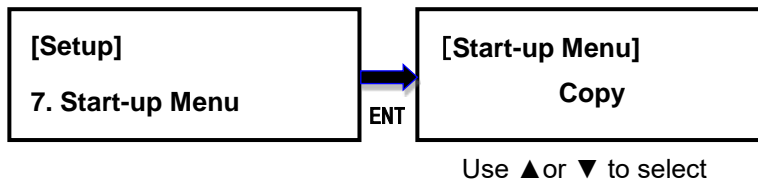

6.7. Button Beep

This option allows to set up button sound from the following options: Button & Warning, OFF, Warning only. The default setting is [Button & Warning](#).

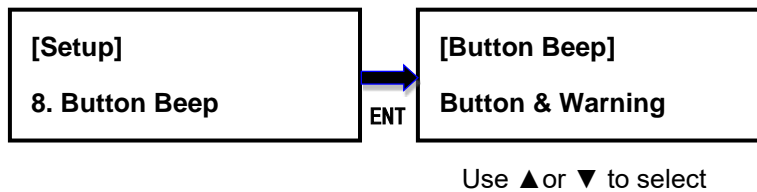

6.8. Show Result Time

This option allows to enable or disable the display of copy time after finishing the copy process. The default setting is [disable](#).

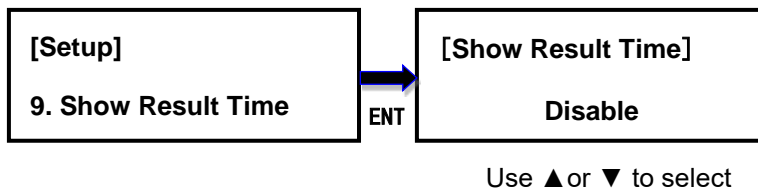

6.9. Boot Password

This option allows to set up password for system boot up to prevent from the unauthorized use of the duplicator. The password must be 6 characters.

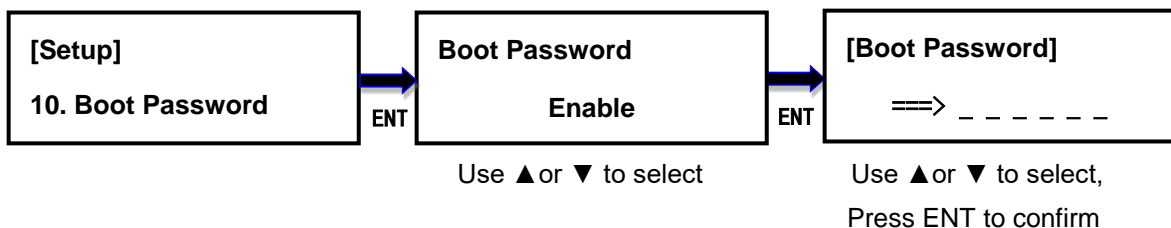

6.10. Setup Password

This option allows to set up password for Setup function to prevent from the change of system settings on the duplicator. The password must be 6 characters.

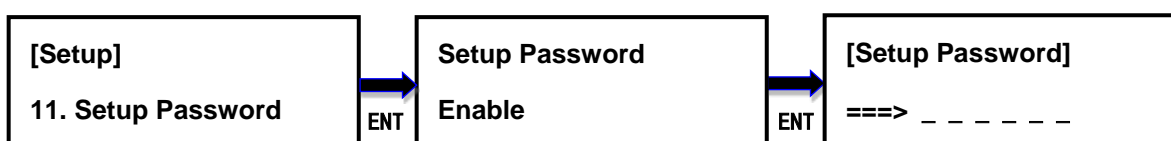

High-Speed Duplicator Controller user manual

Use ▲ or ▼ to select

Use ▲ or ▼ to select,
Press ENT to confirm

6.11. Language

This option allows to choose the language for display: English, Spanish, Portuguese, and Japanese. English is the default [language](#).

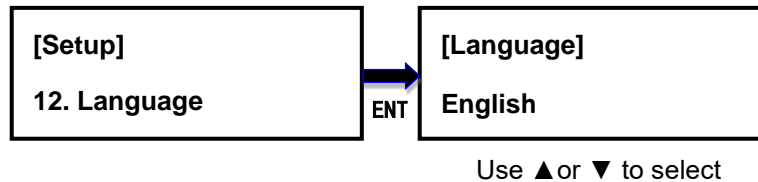

6.12. Clear Setup

This option resets the duplicator back to factory default settings.

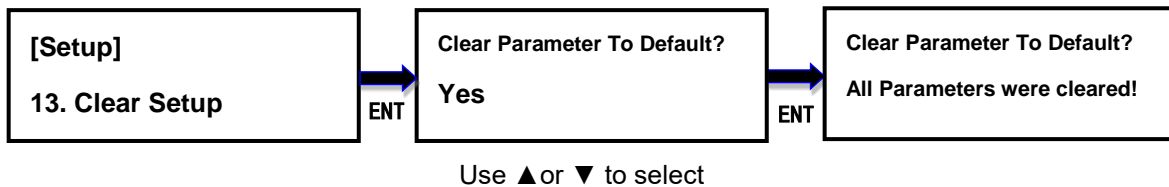

6.13. Performance

This option allows to set up the performance for Copy function based on the following modes: Speed, Balance, and Compatibility. Speed mode is to execute the Copy function at the fastest speed, but may have compatibility issue with certain brands hard disk drive. Balance mode is to execute the Copy function at stable speed, and have less compatibility issue with certain brands hard disk drive. Compatibility mode is to execute the Copy function at the most stable speed, and almost have no compatible issue with hard disk drive. The default mode is [Speed](#).

